

STEELBEAST®

JEI
Solutions
Built for Industry

PRO-60/110 HP

PORTABLE HYDRAULIC PUNCHERS



PRIMARY FEATURES AND BENEFITS

- Double action - fully automated process of punching and return
- Wide range of hole diameters up to 27mm
- Modern construction
- Intelligent control system with inching and automatic load detection
- Mode indicator light
- Protection against accidental start-up
- Easy to handle in out-of-normal positions
- All connecting ports located at the back
- Wide range of special-shaped punches and dies
- Patent pending compact moveable hydraulic power pack
- Unique Gantry Punching Station increases both productivity and operator's comfort

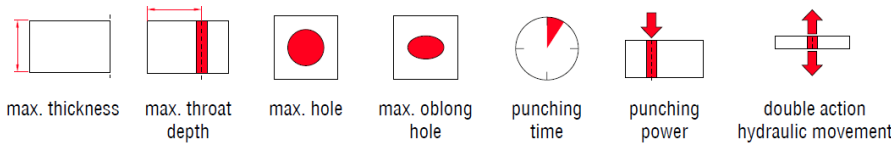

	max. thickness	max. throat depth	max. hole	max. oblong hole	punching time	punching power	double action hydraulic movement
PRO 60 HP	13 mm	60 mm	27 mm	25 x 18 mm	5 sec	35 ton	YES
PRO 110 HP	16 mm	110 mm	27 mm	25 x 18 mm	8 sec	47 ton	YES

CALL 01706 229 490 TO BOOK YOUR DEMONSTRATION NOW OR VISIT WWW.STEELBEAST.CO.UK



PRO-60/110 HP SPECIFICATIONS & DETAILS

Portable Double-Action Hydraulic Puncher Technical Specification	Model PRO 60 HP	Model PRO 110 HP
Max. throat depth	60 mm	110 mm
Max. hole	Ø 27 mm	Ø 27 mm
Max. oblong hole	25 x 18 mm	25 x 18 mm
Punching time	5 sec	8 sec
Max. plate thickness	13 mm	16 mm
Punching power	35 ton	47 ton
Working pressure	700 bar	700 bar
Weight	20 kg	35 kg



Ready to work in both vertical and horizontal positions

Double-Action Hydraulic Power Pack model HPP 700/1.5	
Power supply*	230V/50Hz; 115V/60Hz
Motor power	1500 W
Working pressure	700 bar
Pump output	1.5 L/min
Oil capacity	10 L

* Contact JEI Solutions for other voltage options



Portable hydraulic power pack with shelf for puncher transport.

Balancer for PRO 60 HP; Product code: JEIHPB-60
Balancer for PRO 110 HP; Product code: JEIHPB

Dimensions

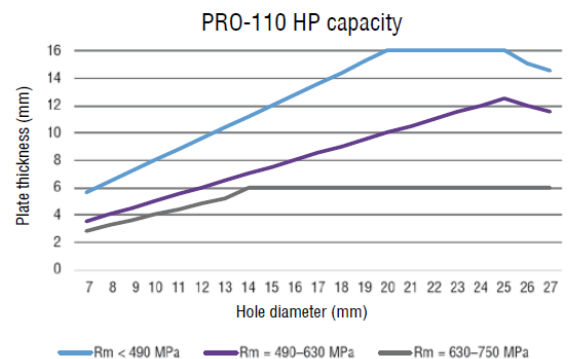
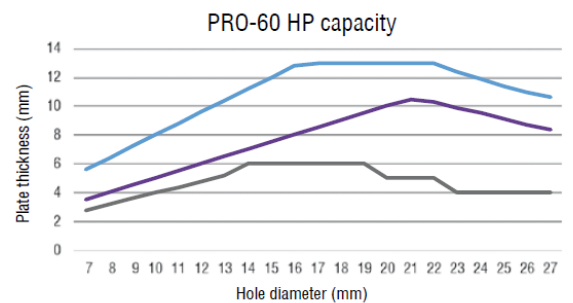
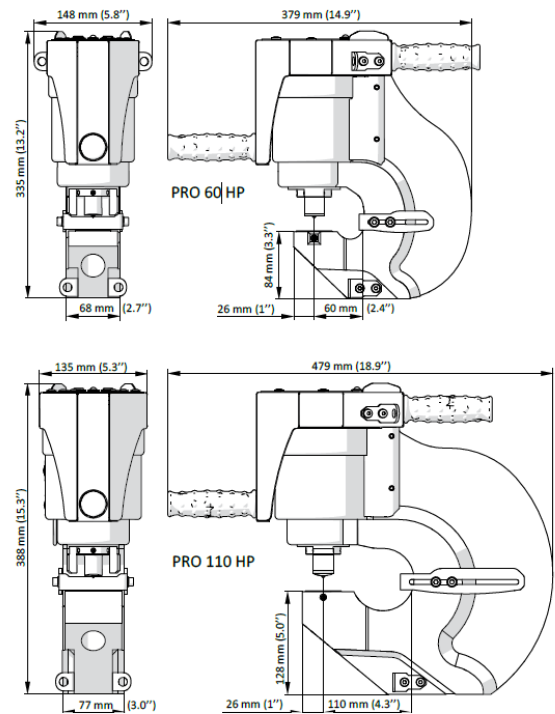

CALL 01706 229 490 TO BOOK YOUR DEMONSTRATION NOW OR VISIT WWW.STEELBEAST.CO.UK



STEELBEAST®

JEI Solutions

Built for Industry

CUSTOMISE YOUR WORK PLACE WITH A VARIETY OF OPTIONAL ACCESSORIES.

HOIST SET Product code: JEIHPH

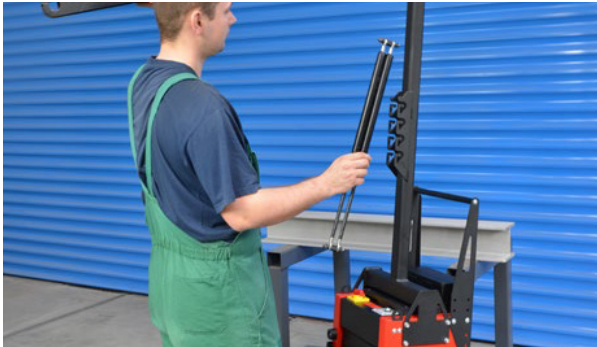

Simple set-up and easy adjustment of height and balance control.

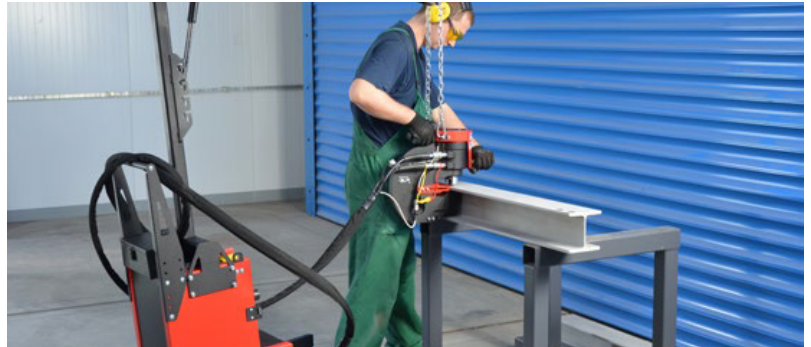

Hoist arm and 2 supports with wheels allow for easy manipulation of punch and power pack as single unit.

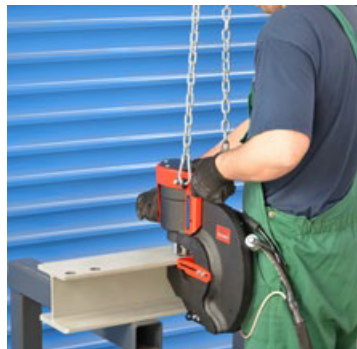

Unique solution which makes your work as efficient and comfortable as never before.

WHEEL PUNCHER SLIDE Product code: JEIHPA900

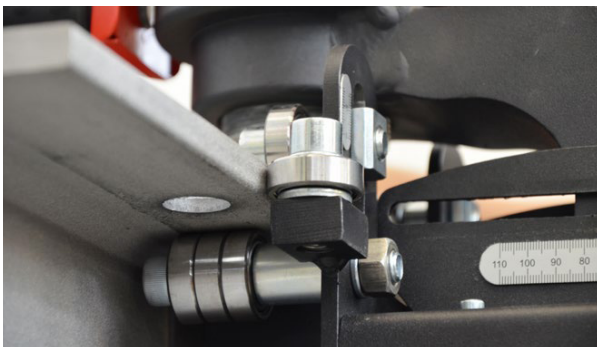

Permits smooth and efficient lineal movement along the workpiece.



CALL 01706 229 490 TO BOOK YOUR DEMONSTRATION NOW OR VISIT WWW.STEELBEAST.CO.UK

WWW.JEIUK.COM

JEI Solutions



CUSTOMISE YOUR WORK PLACE WITH A VARIETY OF OPTIONAL ACCESSORIES.

BENCH TOP STAND WITH FOOT PEDAL Product code: JEIHPA910



Neither balancer nor hoist arm is required to keep puncher in place. An operator can use start and stop bottoms on the machine or foot pedals.

Foot pedal machine control in hands free operation on bench top configuration.

PUNCH AND DIES - ROUND

Diameter (mm)	Punch Part	Die Part
7	JEIPUNCH-R7	JEIDIE-R7
8	JEIPUNCH-R8	JEIDIE-R8
9	JEIPUNCH-R9	JEIDIE-R9
10	JEIPUNCH-R10	JEIDIE-R10
11	JEIPUNCH-R11	JEIDIE-R11
12	JEIPUNCH-R12	JEIDIE-R12
13	JEIPUNCH-R13	JEIDIE-R13
14	JEIPUNCH-R14	JEIDIE-R14
15	JEIPUNCH-R15	JEIDIE-R15
16	JEIPUNCH-R16	JEIDIE-R16
17	JEIPUNCH-R17	JEIDIE-R17
18	JEIPUNCH-R18	JEIDIE-R18
19	JEIPUNCH-R19	JEIDIE-R19
20	JEIPUNCH-R20	JEIDIE-R20
21	JEIPUNCH-R21	JEIDIE-R21
22	JEIPUNCH-R22	JEIDIE-R22
23	JEIPUNCH-R23	JEIDIE-R23
24	JEIPUNCH-R24	JEIDIE-R24
25	JEIPUNCH-R25	JEIDIE-R25
26	JEIPUNCH-R26	JEIDIE-R26
27	JEIPUNCH-R27	JEIDIE-R27

PUNCH AND DIES - OBLONG

Diameter (mm)	Punch Part	Die Part
16x8	JEIPUNCH-O16X8	JEIDIE-O16X8
18x9	JEIPUNCH-O18X9	JEIDIE-O18X9
18x11	JEIPUNCH-O18X11	JEIDIE-O18X11
20x10	JEIPUNCH-O20X10	JEIDIE-O20X10
20x12	JEIPUNCH-O20X12	JEIDIE-O20X12
20x14	JEIPUNCH-O20X14	JEIDIE-O20X14
22x11	JEIPUNCH-O22X11	JEIDIE-O22X11
22x14	JEIPUNCH-O22X14	JEIDIE-O22X14
24x12	JEIPUNCH-O24X12	JEIDIE-O24X12
25x9	JEIPUNCH-O25X9	JEIDIE-O25X9
25x12	JEIPUNCH-O25X12	JEIDIE-O25X12
25x13	JEIPUNCH-O25X13	JEIDIE-O25X13
25x14	JEIPUNCH-O25X14	JEIDIE-O25X14
25x18	JEIPUNCH-O25X18	JEIDIE-O25X18

CALL 01706 229 490 TO BOOK YOUR DEMONSTRATION NOW OR VISIT WWW.STEELBEAST.CO.UK